



PAINTING EQUIPMENT

CATALOGUE

— 2021 —





OUR COMPANY

The Australian Brushware Corporation (ABC) is a leading wholesaler and distributor of quality paint brushes and paint accessories in Australia. We supply to major paint specialists and hardware stores.

Our brand Monarch is renowned for its handcrafted paint brushes and continues to drive the evolution and development of the Australian paint accessory market. Whether you are a professional trade painter or DIYer, Monarch will have the right painting tool for your next painting project.

Our brush products have helped to genuinely revolutionise the move from natural bristle, to a combination of more environmentally sustainable blends, through to synthetic, high-performance brushes.

Under our premium brands (Monarch and Monarch Advance) we are able to offer our consumers a one-stop shop for all their painting accessory needs.

Our comprehensive customer service and sales team, with warehouses throughout Australasia, allows us to deliver industry-leading customer service and support to our customers and consumers.

2020

ABC was awarded a Good Design Award from Good Design Australia for the Monarch Mini Fill Sand Go Multipurpose Filler.

2017

ABC celebrates its 20th anniversary.

2016

Monarch branded products are launched into the UK and IRE markets.

Monarch launches new products in the paint preparation category.

2015

Monarch releases its new innovative compact size Mini Caulking Gun. ABC was awarded a Good Design Selection Award from Good Design Australia for the Monarch Mini compact caulking gun & mini cartridge.

2014

The Monarch Mini compact range of silicones and adhesives is launched into the sealant market.

ABC successfully acquired the distributorship of Shur-Line Painting Products from the US and is now the exclusive distributor in Australia.

2008

The Monarch Detail and Finishing range of paint brushes are successfully introduced into the market.

2005

Monarch expands its business into other paint accessory categories including roller covers, trays, buckets, poles, drop sheets and kits.

2000

ABC contributes to the evolution from pure bristle paint brushes to synthetic brushes with its release of the Monarch Advance premium paint brush.











1997

ABC was established along with the Monarch brand.

New offices and warehouse in Victoria (Campbellfield) are built.



CONTENTS

Our Company		2
Contact Us		4
Paint Brushes		5
Roller Covers / Frames / Kits / Poles		27
Applicators		46
Protection		51
Trays & Buckets		56
Tools		60
Preparation		66
Merchandising		69
Online Resources		71



CONTACT US

CUSTOMER SERVICE

As well as having a wide variety of quality painting tools, we also have a comprehensive national sales force to be able to deliver industry leading customer service, knowledge and support to your business.

Phone 1800 666 078
Email info@austbrush.com.au
Web www.monarchpainting.com

DISTRIBUTION CENTRES

VIC, TAS, SA, ALICE SPRINGS

143-147 National Boulevard,
Campbellfield,
Victoria, 3061

NSW

Nexus Industry Park,
Building 5, 43-47 Lyn Parade,
Prestons, NSW 2170

QLD, DARWIN

Factory 2/509
Boundary Road,
Richlands, QLD 4077

WA

50 Miguel Road,
Bibra Lake,
WA 6163

NZ

14/9 Manu Street,
Otahuhu, Auckland,
NZ 2024



Paint Brushes

Paint Brush Hierarchy 6

Paint Brush DNA 7

Monarch Advance Brushes 8

Detail & Finishing Brushes 13

Swift Brushes 18

Rattail Brushes 20

Xtra Brushes 22

Pure Bristle, Blends & Specialty
Brushes 24

Paint Brush Hierarchy

PROFESSIONAL



Monarch Advance Brushes



BEST



Detail & Finishing Brushes



BETTER



Swift Brushes



Rat Tail Brushes



Xtra Brushes



GOOD

Craftway Brushes

Pure Bristle & Blends

Specialty Paint Brushes



Paint Brush DNA

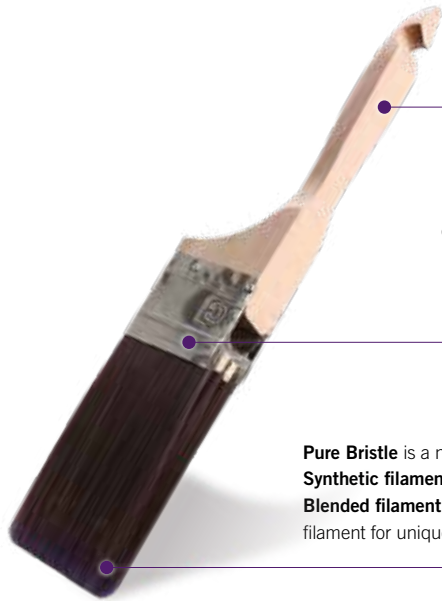

HANDLE

A **raw timber handle** will absorb moisture when used which will cause the natural grain of the wood to raise. This **provides a natural grip** and reduces cramps. Coated or plastic handles prevent moisture from being absorbed, making them difficult to grip for long painting sessions.

FERRULE

High quality pins and ferrules are made from **stainless steel** to prevent rust and **increase durability**. **Premium epoxy resin** is used to bond the filament to the ferrule. **Timber wedges** are inserted to support the filament and enable the brush to maintain its shape. A brush that holds its shape provides an **accurate painting result**. Monarch Advance ferrules have an **aluminium insert** embedded in **epoxy resin** to guarantee **no filament loss**.

FILAMENT

Pure Bristle is a natural fibre ideal for use with oil/enamel based paints.
Synthetic filament is ideal for use with both oil and water based paints.
Blended filament combines the benefits of natural and synthetic filament for unique applications

Paint Brush Quality

VALUE PRICED

- Disposable
- Low cost
- Holds less paint with less coverage
- Filament loss



BEST QUALITY

- Smoother, even paint release
- Holds more paint for greater coverage
- Durable
- Provides a professional finish



Paint Brush Types



PAINT BRUSH

Standard shaped handle with thicker ferrule to hold more paint than any other brush type. Ideal for painting walls, doors, furniture & broad areas.



WALL BRUSH

Slightly thinner than a standard paint brush to be lighter and easier to use. Ideal for painting walls, doors, furniture & broad areas.



SASH CUTTER

Longer handle allows for greater flexibility and control of the brush. Ideal for edging windows, door frames & corners.



ANGLE CUTTER

The long handle gives greater flexibility and control while the angled filament allows for easier cutting in. Ideal for edging windows, door frames & internal corners.



MINI ANGLE CUTTER

Short handles allows for more control in tight areas while the angled filament allows for easier cutting in. Ideal for edging windows, door frames, skirting and moulding.



RAT TAIL

A long thin handle with a pointed tip to allow for greater flexibility, control of brush and easy handling. Ideal for edging windows, door frames & corners.



OVAL BRUSH

Similar to the standard paint brush with an oval ferrule meant to hold more paint. Ideal for painting walls, doors, furniture & broad areas.



OVAL CUTTER

Longer handle allows for greater flexibility and control of brush while the oval shape holds more paint. Ideal for edging windows, door frames & corners.



For the Royal Finish

• SINCE 1997 •

Australia's favourite trade painter's brush containing advanced synthetic filament and the highest quality materials and craftsmanship to provide maximum coverage, durability, control and a royal finish every time.





BRUSHES

- PAINT BRUSH
- WALL BRUSH



MONARCH ADVANCE PAINT BRUSH ■



MONARCH ADVANCE WALL BRUSH ■

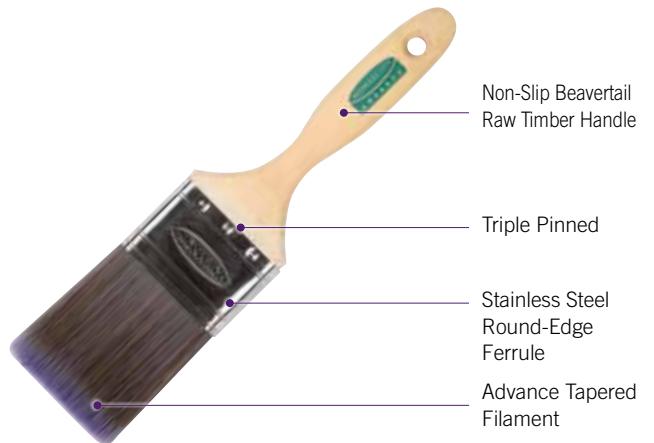

SIZE	CODE	CTN QTY	BARCODE
25mm	AB-9610	6	9 320090 499890
38mm	AB-9615	6	9 320090 499906
50mm	AB-9620	6	9 320090 499913
63mm	AB-9625	6	9 320090 499920
75mm	AB-9630	6	9 320090 499937
88mm	AB-9635	3	9 320090 499944
100mm	AB-9640	3	9 320090 499951

SIZE	CODE	CTN QTY	BARCODE
50mm	AB-89620	6	9 320090 896200
63mm	AB-89625	6	9 320090 896255
75mm	AB-89630	6	9 320090 896309



BRUSHES

- SASH CUTTER
- MINI CUTTER

MONARCH ADVANCE SASH CUTTER ■



MONARCH ADVANCE MINI CUTTER ■

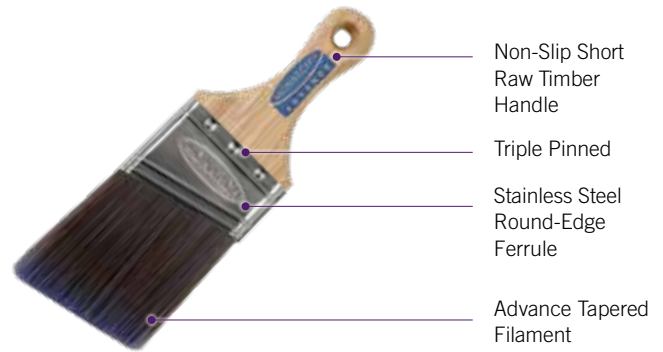

SIZE	CODE	CTN QTY	BARCODE
2PK 2 x 12mm	AB-89705	6	9 320090 1897054
38mm	AB-9515	6	9 320090 499968
50mm	AB-9520	6	9 320090 499975
63mm	AB-9525	6	9 320090 499982
75mm	AB-9530	6	9 320090 499999

SIZE	CODE	CTN QTY	BARCODE
50mm	AB-88120	6	9 320090 4881206



BRUSHES

- ANGLE SASH CUTTER
- OVAL CUTTER



MONARCH ADVANCE ANGLE SASH CUTTER

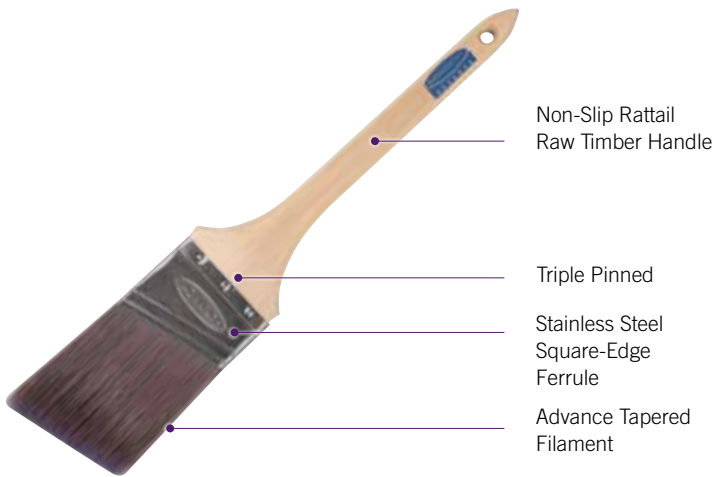

SIZE	CODE	CTN QTY	BARCODE
38mm	AB-89715	6	9 320090 897153
50mm	AB-89720	6	9 320090 897207
63mm	AB-89725	6	9 320090 897252

MONARCH ADVANCE OVAL CUTTER



SIZE	CODE	CTN QTY	BARCODE
38mm	AB-89515	6	9 320090 895159
50mm	AB-89520	6	9 320090 895203
63mm	AB-89525	6	9 320090 895258
75mm	AB-89530	6	9 320090 895302



BRUSHES

- OVAL BRUSH
- BRUSH PACK

MONARCH ADVANCE OVAL BRUSH ■



- Non-Slip Beavertail Raw Timber Handle
- Triple Pinned
- Stainless Steel Oval Shaped Ferrule
- Advance Tapered Filament

SIZE	CODE	CTN QTY	BARCODE
63mm	AB-88225	6	9 320090 882258
75mm	AB-88230	6	9 320090 882302

MONARCH ADVANCE BRUSH PACK ■



SIZE	CODE	CTN QTY	BARCODE
5PCE			
1 x 50mm Paint Brush			
2 x 63mm Sash Cutter	AB-9654S	12	
1 x 75mm Paint Brush			
1 x T-Shirt			9 320090 096549

MONARCH®

Control & Precision

DETAIL & FINISHING

Use the right brush for your next project. This range is slimline, ergonomic and contains advanced synthetic filament to provide a professional finish every time.





BRUSHES



- WALLS, DOORS & TRIMS BRUSH
- MOULDING & SKIRTING BRUSH

MONARCH WALLS, DOORS & TRIMS BRUSH ■

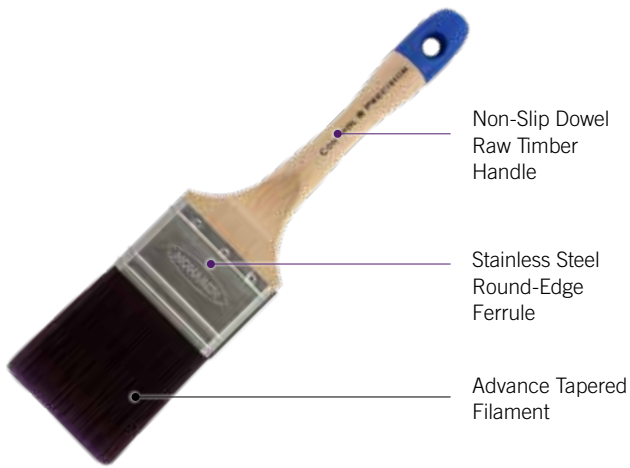

MONARCH MOULDING & SKIRTING BRUSH ■

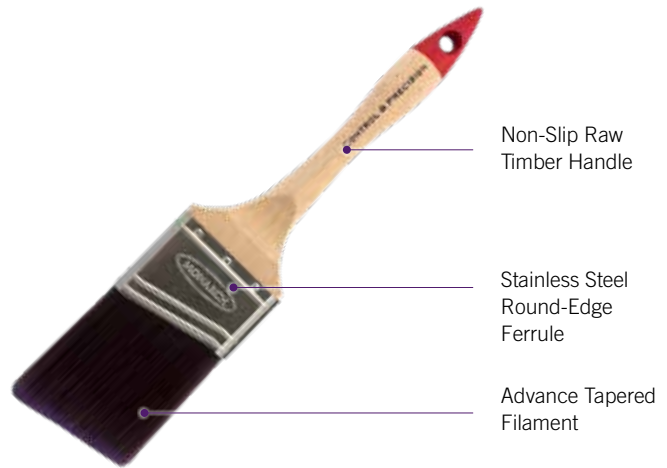

SIZE	CODE	CTN QTY	BARCODE
50mm	BM7022	6	9 320090 070228
63mm	BM7023	6	9 320090 070235
75mm	BM7024	6	9 320090 070242

SIZE	CODE	CTN QTY	BARCODE
38mm	BM7030	6	9 320090 070303
50mm	BM7031	6	9 320090 070310
63mm	BM7032	6	9 320090 070327
75mm	BM7033	6	9 320090 070334

BRUSHES

- █ CUTTING IN & FRAMING BRUSH
- █ CORNICE & CEILING BRUSH
- █ WINDOWS & DOORS BRUSH



MONARCH CUTTING IN & FRAMING BRUSH



- Non-Slip Short Raw Timber Handle
- Stainless Steel Square-Edge Ferrule
- Advance Tapered Filament

SIZE	CODE	CTN QTY	BARCODE
50mm	BM7027	6	9 320090 070273
63mm	BM7028	6	9 320090 070280
75mm	BM7029	6	9 320090 070297

MONARCH CORNICE & CEILING BRUSH



- Non-Slip Fluted Raw Timber Handle
- Stainless Steel Round-Edge Ferrule
- Advance Tapered Filament

SIZE	CODE	CTN QTY	BARCODE
38mm	BM7035	6	9 320090 070358
50mm	BM7036	6	9 320090 070365

MONARCH WINDOWS & DOORS BRUSH



- Non-Slip Raw Timber Handle
- Stainless Steel Triangle Ferrule
- Advance Tapered Triangle Shape Filament

SIZE	CODE	CTN QTY	BARCODE
22mm	BM7038	6	9 320090 070389
33mm	BM7039	6	9 320090 070396



BRUSHES

- ARCHITRAVE & SKIRTING BRUSH
- DETAIL & FINISHING BRUSH



MONARCH ARCHITRAVE & SKIRTING BRUSH

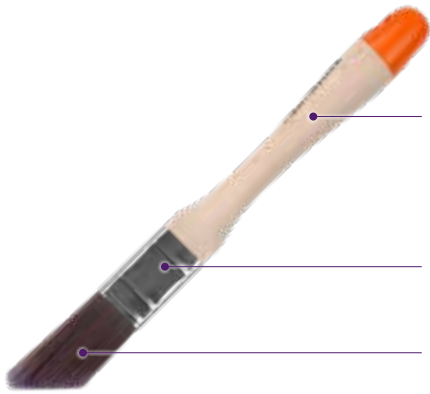

Non-Slip Dowel
Raw Timber
Handle

Stainless Steel
Square Ferrule

Advance Tapered
Square Shape
Filament

MONARCH DETAIL & FINISHING BRUSH



Non-Slip Raw
Timber Handle

Stainless Steel
Round Ferrule

Advance Tapered
Round Shape
Filament

SIZE	CODE	CTN QTY	BARCODE
25mm	BM7037	6	9 320090 070372

SIZE	CODE	CTN QTY	BARCODE
25mm	BM7034	6	9 320090 070341



BRUSHES

- █ FENCE BRUSH
- █ SAMPLE POT BRUSH



MONARCH FENCE BRUSH █

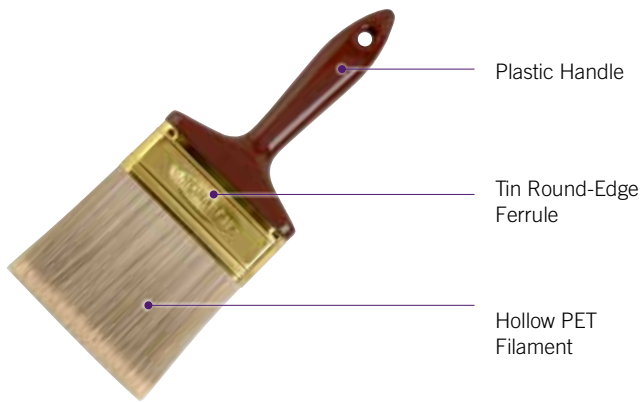

SIZE	CODE	CTN QTY	BARCODE
100mm	BS-8755	12	9 320090 087554

MONARCH SAMPLE POT BRUSH █ 2PK

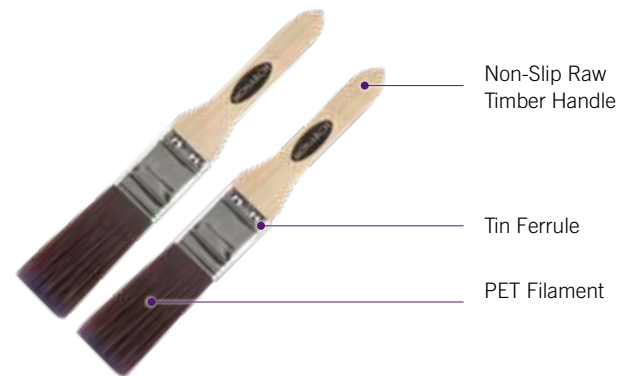

SIZE	CODE	CTN QTY	BARCODE
2PK 2 x 25mm	BM7123	48	9 320090 071232

MONARCH®

Swift

Trade Choice

Quality Synthetic Filament
Durable & Easy to Clean
Suitable for All Paints



BRUSHES

- SWIFT WALL BRUSH
- SWIFT SASH CUTTER
- SWIFT OVAL CUTTER



MONARCH SWIFT WALL BRUSH



Non-Slip
Beavertail Raw
Timber Handle

Stainless Steel
Square-Edge
Ferrule

PET Filament

SIZE	CODE	CTN QTY	BARCODE
38mm	MPB-1959	6	9 320090 019593
50mm	MPB-1960	6	9 320090 019609
63mm	MPB-1961	6	9 320090 019616
75mm	MPB-1962	6	9 320090 019623
88mm	MPB-1963	6	9 320090 019630

MONARCH SWIFT SASH CUTTER



Non-Slip Fluted
Raw Timber
Handle

Stainless Steel
Square-Edge
Ferrule

PET Filament

SIZE	CODE	CTN QTY	BARCODE
38mm	MPB-1964	6	9 320090 019647
50mm	MPB-1965	6	9 320090 019654
63mm	MPB-1966	6	9 320090 019661
75mm	MPB-1967	6	9 320090 019678

MONARCH SWIFT OVAL CUTTER

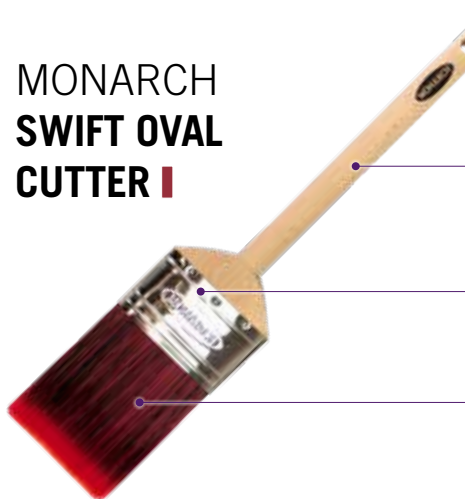

Non-Slip Long
Raw Timber
Handle

Stainless Steel
Semi-Oval
Ferrule

PET Filament

SIZE	CODE	CTN QTY	BARCODE
50mm	MPB-1968	6	9 320090 019685
63mm	MPB-1969	6	9 320090 019692
75mm	MPB-1970	6	9 320090 019708



Rat Tail

Fast & Sharp



Long Handle for Comfortable Control
Ideal for Cutting In & Trimming around Doors,
Windows & Skirting Boards





BRUSHES

- RATTAIL ANGLE SASH CUTTER
- RATTAIL BRUSH PACK



MONARCH RATTAIL ANGLE SASH CUTTER ■



SIZE	CODE	CTN QTY	BARCODE
25mm	AB-8510	6	9 320090 085109
38mm	AB-8515	6	9 320090 085154
50mm	AB-8520	6	9 320090 085208
63mm	AB-8525	6	9 320090 085253

MONARCH RATTAIL BRUSH PACK ■



SIZE	CODE	CTN QTY	BARCODE
3PK 1 x 50mm Angle Cutter 2 x 63mm Angle Cutter	AB-8551	6	9 320090 085512

MONARCH[®]

Xtra Coverage

Get the XTRA coverage you need with a good quality brush that's easy to clean & suitable for all paints

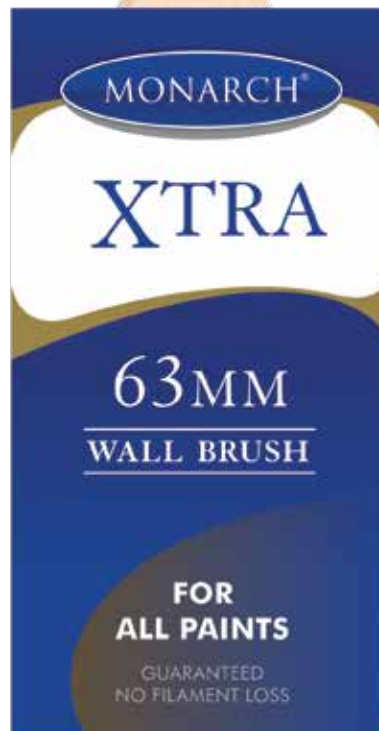



BRUSHES

XTRA WALL BRUSH



MONARCH XTRA WALL BRUSH



SIZE	CODE	CTN QTY	BARCODE
25mm	AB-9210	6	9 320090 192104
38mm	AB-9215	6	9 320090 192159
50mm	AB-9220	6	9 320090 192203
63mm	AB-9225	6	9 320090 192258
75mm	AB-9230	6	9 320090 192302
100mm	AB-9240	3	9 320090 192401



BRUSHES

- CRAFTWAY BRUSH
- STAINS, OILS & VARNISH BRUSH

MONARCH CRAFTWAY BRUSH



SIZE	CODE	CTN QTY	BARCODE
25mm	AB-7910	6	9 320090 079108
38mm	AB-7915	6	9 320090 079153
50mm	AB-7920	6	9 320090 079207
63mm	AB-7925	6	9 320090 079252
75mm	AB-7930	6	9 320090 079306
100mm	AB-7940	3	9 320090 079405

MONARCH STAINS, OILS & VARNISH BRUSH



SIZE	CODE	CTN QTY	BARCODE
25mm	AB-8610	36	9 320090 086106
38mm	AB-8615	36	9 320090 086151
50mm	AB-8620	24	9 320090 086205



BRUSHES

- BEVEL LINING FITCH
- RADIATOR BRUSH



MONARCH BEVEL LINING FITCH



MONARCH RADIATOR BRUSH

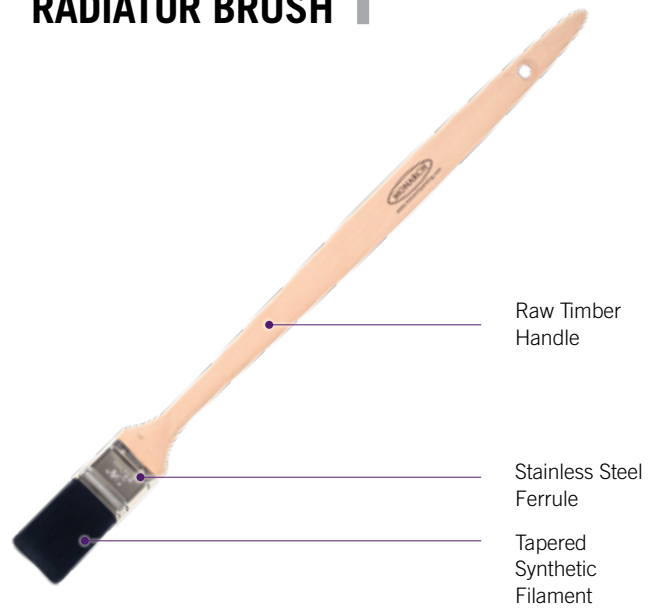

SIZE	CODE	CTN QTY	BARCODE
6mm	BM7118	12	9 320090 071188
12mm	BM7119	12	9 320090 071195
18mm	BM7120	12	9 320090 071201
2PK 25mm 30mm	BM7121	12	9 320090 071218

SIZE	CODE	CTN QTY	BARCODE
25mm	BM7114	3	9 320090 071140
38mm	BM7115	3	9 320090 071157
50mm	BM7116	3	9 320090 071164



BRUSHES

FIBREGLASS CHIP BRUSH



FIBREGLASS CHIP BRUSH

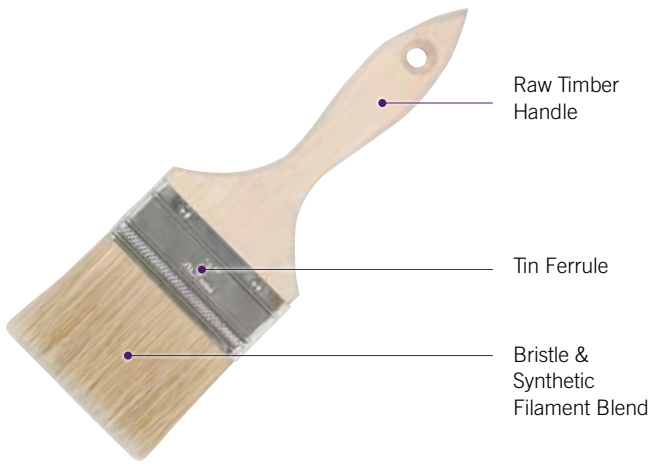

SIZE	CODE	CTN QTY	BARCODE
25mm	AB-6710	6	9 320090 067105
38mm	AB-6715	6	9 320090 067150
50mm	AB-6720	6	9 320090 067204
63mm	AB-6725	6	9 320090 067259
75mm	AB-6730	6	9 320090 067303
100mm	AB-6740	3	9 320090 067402



Rollers

Roller Cover DNA	28
------------------	----

Trade Choice Roller Covers	30
----------------------------	----

Task Roller Covers	32
--------------------	----

Seamless Foam Roller Covers	35
-----------------------------	----

Roller Frames	37
---------------	----

Mini Roller Kits	38
------------------	----

Roller Kits	40
-------------	----

Extension Poles	44
-----------------	----

Roller Cover DNA



NAP

Roller covers come in different nap or fabric heights to suit different applications and paint types. The nap length and material will determine how much paint is held in the roller and how the paint is released. Choose the right nap length based on your project below.

CORE

A good quality core will ensure a strong hold on the roller frame and material, as well as be able to hold it's shape when in use for a smooth paint finish. Monarch roller covers come with a PP core, except for the seamless foam in our trade range which have a phenolic core.

LENGTH

Roller length varies and should be matched to the scope of the painting project. The standard lengths are 230mm or 270mm but non-standard lengths are easily available.

Nap Length Guide

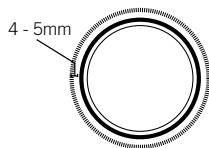

4 - 5mm NAP

IDEAL PAINT TYPES: **Gloss/Semi-Gloss Paint**

PAINTING PROJECTS:
Doors, Cupboards, Benchtops, Smooth Surfaces

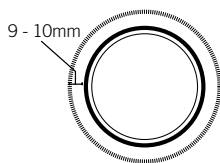

9 - 10mm NAP

IDEAL PAINT TYPES: **Low Sheen/Semi-Gloss Paint**

PAINTING PROJECTS:
Interior Walls, Laundry's, Bathrooms, MDF, Timber, Ply Wood

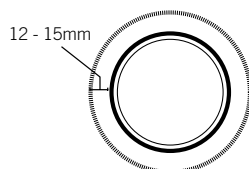

12 - 15mm NAP

IDEAL PAINT TYPES: **Flat/Low Sheen Paint**

PAINTING PROJECTS:
Ceilings, Plaster, Textured Walls, Wallpaper, Eaves, Cement Sheeting

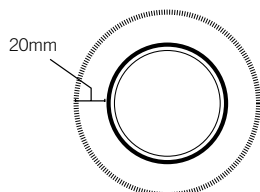

20mm NAP

IDEAL PAINT TYPES: **Flat/Low Sheen Paint**

PAINTING PROJECTS:
Brick, Render, Concrete Floors, Driveways, Paths, Masonry

Roller Cover Materials



MICROFIBRE

A very popular shed resistant (lint free) roller cover fabric made of elastic and resilient fibres. A superior microfibre quality with fantastic paint pick-up and release providing the ultimate super smooth finish. Most suitable for water-based paints.



SEAMLESS FOAM

Seamless foam roller covers have a short nap length to deliver the best results when used for gloss and semi-gloss finishes. Being 'seamless' ensures there are no roller marks. Most suitable for oil-based paints.

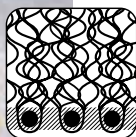

FABRIC (KNITTED FABRIC)

Knitted fabric (commonly referred to as 'fabric' or simply 'polyester') is mostly used when project speed and coverage are important. Most fabrics have a great paint pick up and release which ensures fast wash out and cleaning.

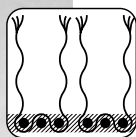
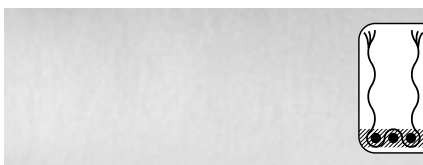

WOVEN POLYESTER (WOVEN FABRIC)

Woven fabric (commonly 'woven polyester') is created with a double 'woven' fibre attachment that makes it very durable and able to provide a better finish. Like knitted fabric, woven polyester is used when project speed and coverage are important with great paint pick up and release.

Finishing Processes

Our roller covers go through a rigorous finishing process during manufacturing. This includes fluffing up fibres, trimming of excess fabric, bevelling the roller cover ends and vacuuming loose fibres. The thoroughness of the finishing process ensures the high quality of our roller covers and their superior performance.

Roller Cover Quality

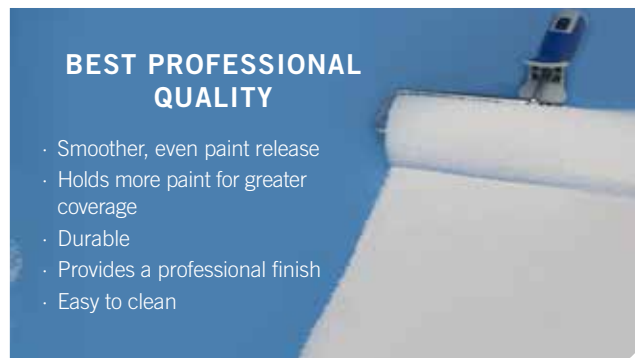

MONARCH[®]

Professional Microfibre

TRADE CHOICE

Highly Absorbent & Superior Coverage
Professional Smooth Finish
High Density Microfibre





ROLLER COVERS

- MICROFIBRE - 4mm NAP
- MICROFIBRE - 10mm NAP
- MICROFIBRE - 15mm NAP



MONARCH MICROFIBRE ROLLER COVER 4mm Nap ■

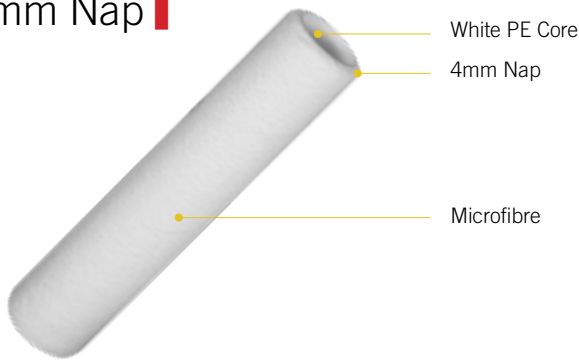

SIZE	CODE	CTN QTY	BARCODE
230mm	MRM-2716	8	9 320090 027161
270mm	MRM-2717	8	9 320090 027178
4PK 4 x 230mm	RM2732	6	9 320090 027321
4PK 4 x 270mm	MRM-2729	6	9 320090 027291

MONARCH MICROFIBRE ROLLER COVER 10mm Nap ■

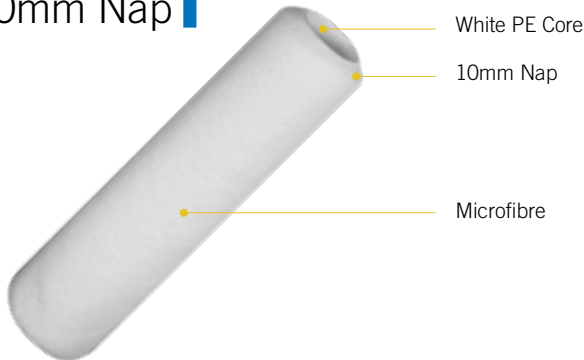

SIZE	CODE	CTN QTY	BARCODE
230mm	MRM-2720	8	9 320090 027208
270mm	MRM-2721	8	9 320090 027215
4PK 4 x 230mm	RM2733	6	9 320090 027338
4PK 4 x 270mm	MRM-2731	6	9 320090 027314

MONARCH MICROFIBRE ROLLER COVER 15mm Nap ■



SIZE	CODE	CTN QTY	BARCODE
230mm	MRM-2724	8	9 320090 027246
270mm	MRM-2725	8	9 320090 027253

MONARCH®

Task Driven

ROLLER COVERS

Quality Smooth Finish
Suitable for All Paints
Minimal Lint





ROLLER COVERS

- DOORS, TRIMS & CUPBOARDS - 4mm NAP
- ALL PURPOSE - 9mm NAP



MONARCH DOORS, TRIMS & CUPBOARDS ROLLER COVER - 4mm Nap

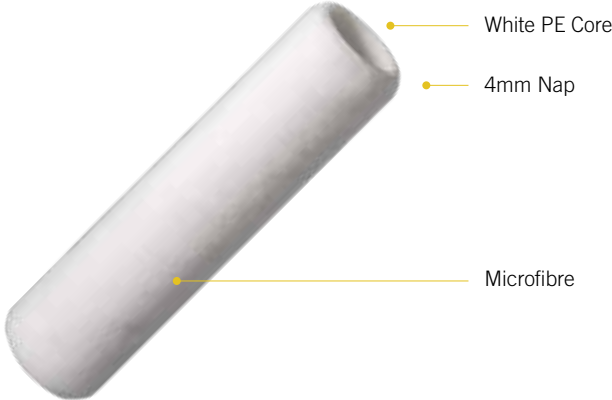

MONARCH ALL PURPOSE ROLLER COVER - 9mm Nap

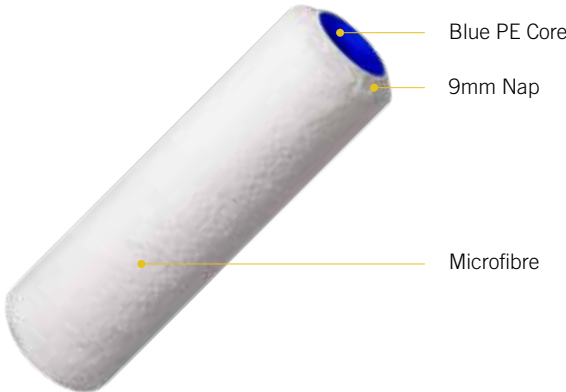

SIZE	CODE	CTN QTY	BARCODE
75mm	MT-RC-8424	12	9 320090 084249
130mm	MT-RC-8425	12	9 320090 084256
180mm	MT-RC-8426	12	9 320090 084263
230mm	MT-RC-8430	12	9 320090 084300
270mm	MT-RC-8435	12	9 320090 084355

SIZE	CODE	CTN QTY	BARCODE
180mm	MT-RC-8427	12	9 320090 084270
230mm	MT-RC-8431	12	9 320090 084317
270mm	MT-RC-8436	12	9 320090 084362



ROLLER COVERS

- WALLS & CEILINGS - 12mm NAP
- ROUGH & TEXTURED SURFACES - 20mm NAP

MONARCH WALLS & CEILINGS ROLLER COVER - 12mm Nap

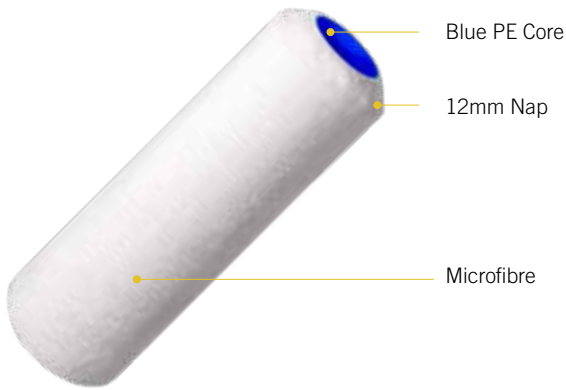

MONARCH ROUGH & TEXTURED SURFACES ROLLER COVER - 20mm Nap

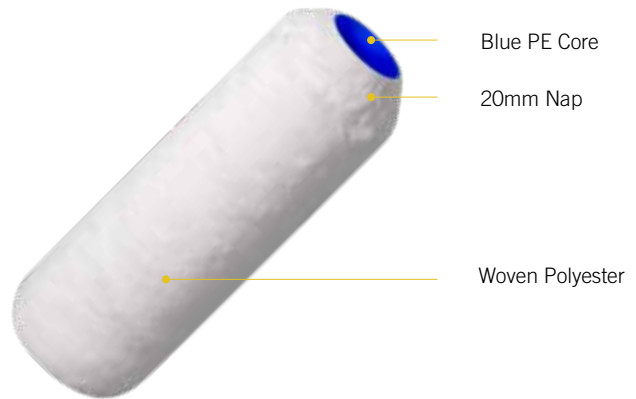

SIZE	CODE	CTN QTY	BARCODE
180mm	MT-RC-8428	12	9 320090 084287
230mm	MT-RC-8432	12	9 320090 084324
270mm	MT-RC-8437	12	9 320090 084379

SIZE	CODE	CTN QTY	BARCODE
180mm	MT-RC-8429	12	9 320090 084294
230mm	MT-RC-8433	8	9 320090 084331
270mm	MT-RC-8438	8	9 320090 084386

MONARCH[®]

Seamless Quality



FOAM ROLLER COVER

Super Smooth Finish

Ideal for Use with Gloss & Semi Gloss Paints

Perfect for Doors, Trims & Cupboards



MONARCH®

ROLLER COVERS

- SEAMLESS FOAM
- SEAMLESS FOAM PACK



MONARCH SEAMLESS FOAM ROLLER COVER ■

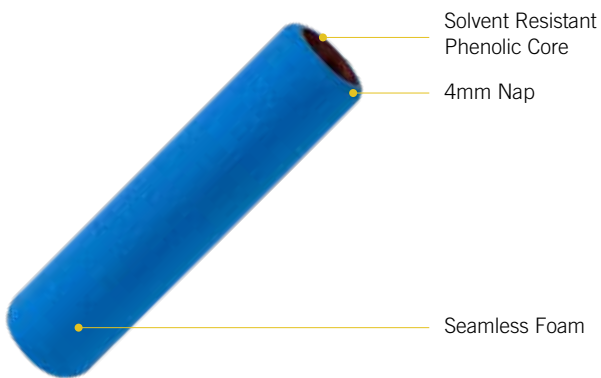

MONARCH SEAMLESS FOAM ROLLER COVER PACK - 4PK ■

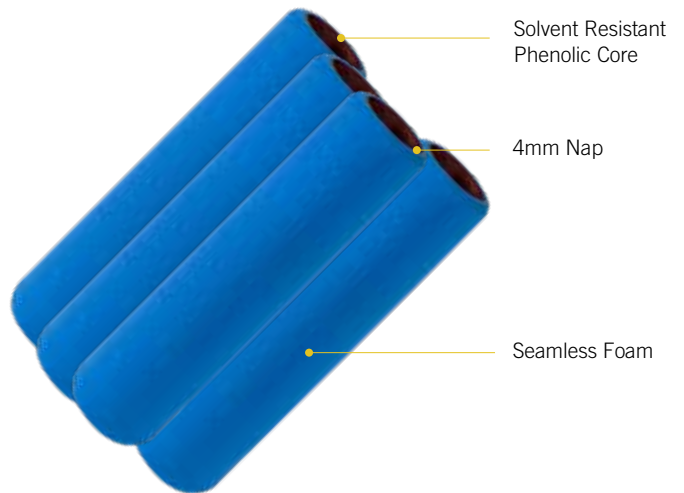

SIZE	CODE	CTN QTY	BARCODE
230mm	MF-RC-8451	8	9 320090 084515
270mm	MF-RC-8453	8	9 320090 084539

SIZE	CODE	CTN QTY	BARCODE
4PK 4 x 230mm	MF-RC-8452	6	9 320090 084522
4PK 4 x 270mm	MF-RC-8454	6	9 320090 084546



ROLLER FRAMES

- HEAVY DUTY ROLLER FRAME
- YOKE FRAME



MONARCH HEAVY DUTY ROLLER FRAME

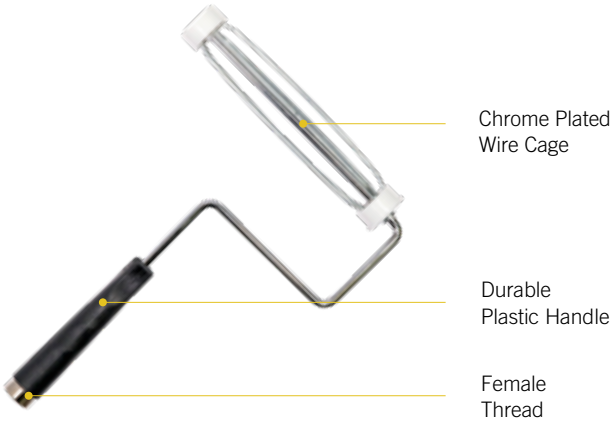

MONARCH YOKE FRAME



SIZE	CODE	CTN QTY	BARCODE
75mm	3640	24	9 320090 036408
180mm	7850	12	9 320090 078507
230mm	9850	12	9 320090 098505
270mm	10850	12	9 320090 108501

SIZE	CODE	CTN QTY	BARCODE
270mm to 460mm	U-234	6	9 320090 002342



MINI ROLLER KITS

- HIGH DENSITY FOAM MINI ROLLER - 9mm NAP
- MICROFIBRE MINI ROLLER - 4mm NAP

MONARCH
HIGH DENSITY FOAM - 9mm Nap ■
 Mini Roller Kit 4PCE

MONARCH
MICROFIBRE - 4mm Nap ■
 Mini Roller Kit 4PCE



SIZE	CODE	CTN QTY	BARCODE
100mm	KM4152	6	9 320090 034152

SIZE	CODE	CTN QTY	BARCODE
100mm	KM4169	6	9 320090 034169



MINI ROLLER KITS

- MICROFIBRE MINI ROLLER - 11mm NAP
- FABRIC MINI ROLLER - 10mm NAP



MONARCH
MICROFIBRE - 10mm Nap ■
 Mini Roller Kit 4PCE

MONARCH
FABRIC - 11mm Nap ■
 Mini Roller Kit 4PCE



SIZE	CODE	CTN QTY	BARCODE
100mm	KM4176	6	9 320090 034152

SIZE	CODE	CTN QTY	BARCODE
100mm	KM4183	6	9 320090 034169

MONARCH®

Project Based

ROLLER KITS

Ideal for Small Projects

Suitable for All Paint Types



ROLLER KITS

- █ FINISHING TOUCHES
- █ DOORS, TRIMS & CUPBOARDS
- █ FURNITURE, DOORS & CUPBOARDS



MONARCH FINISHING TOUCHES - 75mm █ Roller Kit 4PCE



- Cage Roller Frame with Rubber Handle
- 75mm 12mm Nap Roller Cover
- 75mm 4mm Nap Roller Cover
- Roller Tray

SIZE	CODE	CTN QTY	BARCODE
75mm	KT-1103	6	9 320090 011030

MONARCH DOORS, TRIMS & CUPBOARDS - 130mm █ Roller Kit 3PCE



- Cage Roller Frame with Rubber Handle
- 130mm 5mm Nap Roller Cover
- Roller Tray

SIZE	CODE	CTN QTY	BARCODE
130mm	KT-3132	6	9 320090 031328

MONARCH FURNITURE, DOORS & CUPBOARDS - 160mm █ Roller Kit 4PCE



- Cage Roller Frame with Rubber Handle
- 2 x 160mm 10mm Nap Roller Cover
- Roller Tray

SIZE	CODE	CTN QTY	BARCODE
160mm	KT-3246	6	9 320090 032462

MONARCH®

ROLLER KITS

- WALLS & CEILINGS
- MICROFIBRE
- FENCE, DECK & PERGOLA



MONARCH WALLS & CEILINGS - 130mm Roller Kit 3PCE



Cage Roller
Frame with
Rubber Handle

130mm
12mm Nap
Roller Cover

Roller Tray

SIZE	CODE	CTN QTY	BARCODE
130mm	KT-3133	6	9 320090 031335

MONARCH MICROFIBRE - 160mm Roller Kit 4PCE



Cage Roller
Frame with
Rubber Handle

2 x 160mm
10mm Nap
Roller Cover

Roller Tray

SIZE	CODE	CTN QTY	BARCODE
160mm	KT-3134	6	9 320090 031342

MONARCH FENCE, DECK & PERGOLA - 130mm Roller Kit 3PCE



Cage Roller
Frame with
Rubber Handle

130mm
20mm Nap
Roller Cover

Roller Tray

SIZE	CODE	CTN QTY	BARCODE
130mm	KT-3243	6	9 320090 032431



ROLLER KITS

TRADE CHOICE ROLLER KIT



MONARCH TRADE CHOICE ROLLER KIT



SIZE	CODE	CTN QTY	BARCODE
230mm	MRTKIT-2160	6	9 320090 021602
270mm	MRTKIT-2161	6	9 320090 021619

MONARCH®

The Sky's the Limit

EXTENSION POLES

Reach all heights with Monarch's range of painting extension poles.

Usable with all standard roller frames.





EXTENSION POLES

- STEEL FIXED POLE
- ALUMINIUM EXTENSION POLE



MONARCH STEEL FIXED POLE



LENGTH	CODE	CTN QTY	BARCODE
1.2m	EX-1316	6	9 320090 013164

MONARCH ALUMINIUM EXTENSION POLE

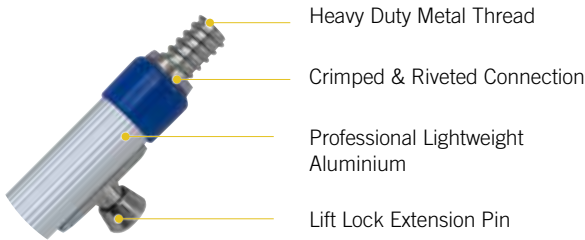

LENGTH	CODE	CTN QTY	BARCODE
0.6-1.2m	EX-1374	6	9 320090 013744
1.2-2.4m	EX-1375	6	9 320090 013751
1.8-3.6m	EX-1376	6	9 320090 013768



Applicators

Mini Roller Packs	47
-------------------	----

Mini Roller Frames	50
--------------------	----

MONARCH[®]

Trade Choice Quality

MINI ROLLERS

Heavy Duty Mini Roller Frames

Available in 100mm, Twin Pack & 10 Pack Refills

Foam, Microfibre & Fabric



MONARCH®

MINI ROLLERS

- HIGH DENSITY FOAM MINI ROLLER - 9mm NAP
- MICROFIBRE MINI ROLLER - 4mm NAP



MONARCH HIGH DENSITY FOAM MINI ROLLER - 9mm Nap ■

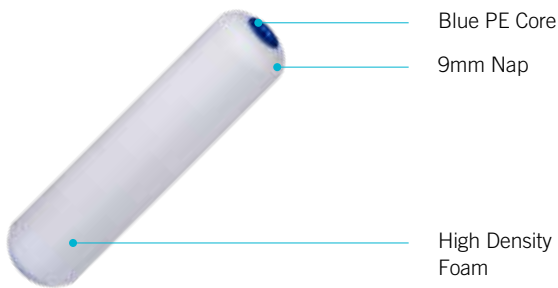

MONARCH MICROFIBRE MINI ROLLER - 4mm Nap ■



SIZE	CODE	CTN QTY	BARCODE
2PK 2 x 100mm	M-MR-1660	12	9 320090 016608
10PK 10 x 100mm	M-MR-1661	6	9 320090 016615

SIZE	CODE	CTN QTY	BARCODE
2PK 2 x 100mm	M-MR-1672	12	9 320090 016721
10PK 10 x 100mm	M-MR-1673	6	9 320090 016738



MINI ROLLERS

- MICROFIBRE MINI ROLLER - 10mm NAP
- FABRIC MINI ROLLER - 10mm NAP



MONARCH MICROFIBRE MINI ROLLER - 10mm Nap

MONARCH FABRIC MINI ROLLER - 10mm Nap

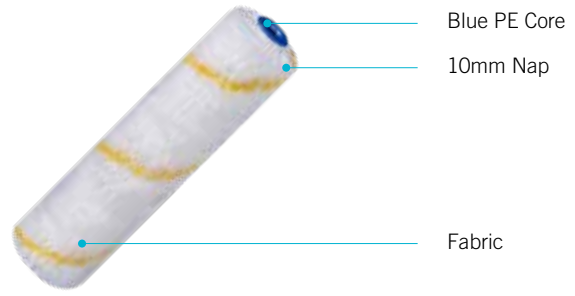

SIZE	CODE	CTN QTY	BARCODE
2PK 2 x 100mm	M-MR-1664	12	9 320090 016646
10PK 10 x 100mm	M-MR-1665	6	9 320090 016653

SIZE	CODE	CTN QTY	BARCODE
2PK 2 x 100mm	M-MR-1666	12	9 320090 016660
10PK 10 x 100mm	M-MR-1667	6	9 320090 016677

MONARCH®

MINI ROLLERS

- SHORT HANDLE FRAME
- LONG HANDLE FRAME

MONARCH MINI ROLLER FRAME

Short Handle

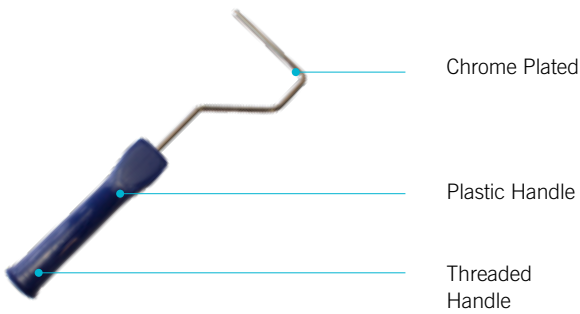

MONARCH MINI ROLLER FRAME

Long Handle

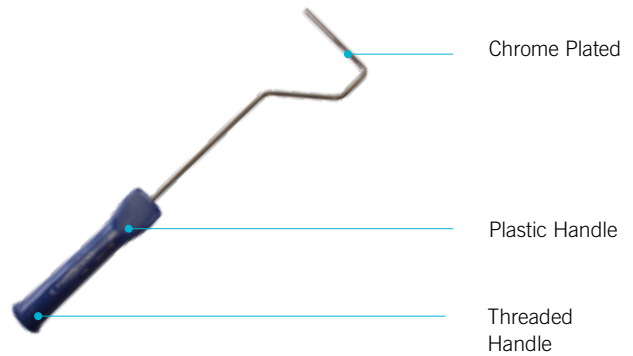

SIZE	CODE	CTN QTY	BARCODE
100mm	M-MR-1670	12	9 320090 016707

SIZE	CODE	CTN QTY	BARCODE
100mm	M-MR-1676	12	9 320090 016769



Protection

Drop Sheet DNA	52
----------------	----

Canvas Drop Sheets	53
--------------------	----

Canvas Drop Sheets / Plastic Drop Sheets	54
--	----

Drop Sheet DNA



CANVAS DROP SHEET WITH RUBBER BACKING

Heavy duty canvas with rubber backing provides durable, non-slip, leak-proof protection that grips the floor. Ideal for wooden floors & tiles and suitable for furniture & carpets



CANVAS DROP SHEET WITH PLASTIC BACKING

Heavy duty canvas with plastic backing provides durable, leak-proof protection for furniture, floors, carpet & tiles. These drop sheets have double-sided hemming and are 100% leak-proof protection for your painting project.



CANVAS DROP SHEET

Heavy duty and durable interior protection for furniture, floors, carpet & tiles. The professional quality canvas has double sided hemming and will provide good protection against paint spatter.



HEAVY DUTY PLASTIC SHEET

Interior and exterior protection for furniture, floors, carpet, tiles and windows. Heavy duty plastic will resist tears and comes with an embossed safety grip pattern to reduce slippage. 100% leak-proof.



LIGHTWEIGHT PLASTIC SHEET

Disposable interior and exterior protection for furniture, floors, carpet, tiles and windows. Clear light weight plastic. Water proof.

Standard Drop Sheet Sizes

5' x 5'
1.5m x 1.5m



4' x 20'
1.2m x 6.0m



5' x 12'
1.5m x 3.6m



9' x 12'
2.6m x 3.6m

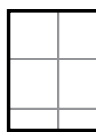

12' x 12'
3.6m x 3.6m

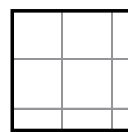

12' x 15'
3.6m x 4.5m

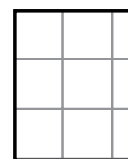

12' x 18'
3.6m x 5.5m

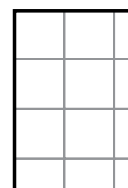



DROP SHEETS

- CANVAS DROP SHEET - 8OZ
- RUBBER BACKED CANVAS DROP SHEET





MONARCH CANVAS DROP SHEET - 8oz ■



SIZE	CODE	CTN QTY	BARCODE
3.6m x 3.6m	MTDS-10130	5	 9 320090 101304
3.6m x 4.5m	MTDS-10131	4	 9 320090 101311
3.6m x 5.5m	MTDS-10132	3	 9 320090 101328
1.5m x 3.6m	MTDS-10133	6	 9 320090 101335
2.6m x 3.6m	MTDS-10134	6	 9 320090 101342
1.2m x 6.0m	MTDS-10136	9	 9 320090 101366
3PK 1 x 1.5m x 1.5m 1 x 1.5m x 3.6m 1 x 2.6m x 3.6m	MTDS-10135	4	 9 320090 101359

MONARCH CANVAS DROP SHEET - Rubber Backed ■



SIZE	CODE	CTN QTY	BARCODE
1.5m x 3.6m	TDS-10125	6	 9 320090 101250
2.6m x 3.6m	TDS-10126	6	 9 320090 101267



DROP SHEETS

- LEAK-PROOF CANVAS DROP SHEET
- PLASTIC DROP SHEET

MONARCH LEAK-PROOF CANVAS DROP SHEET ■



Plastic Backed Canvas

MONARCH PLASTIC DROP SHEET ■

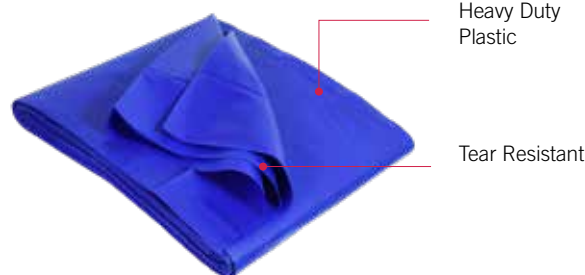

Heavy Duty Plastic

Tear Resistant

SIZE	CODE	CTN QTY	BARCODE
1.5m x 3.6m	DS-10100	6	9 320090 101007
1.5m x 1.5m	DS-10101	12	9 320090 101014
2.6m x 3.6m	DS-10103	6	9 320090 101038
3.6m x 3.6m	DS-10102	6	9 320090 101021

SIZE	CODE	CTN QTY	BARCODE
2.6m x 3.6m	TBDS-1402	40	9 320090 014024



DROP SHEETS

CLEAR PLASTIC DROP SHEET



MONARCH CLEAR PLASTIC DROP SHEET



Lightweight
Plastic

SIZE	CODE	CTN QTY	BARCODE
2.6m x 3.6m	MDS-1434	40	 9 320090 014345



Trays & Buckets

Paint Trays 57

Paint Pots 59



PAINT TRAYS

- HEAVY DUTY TRAY
- TRAY LINERS



MONARCH HEAVY DUTY TRAY

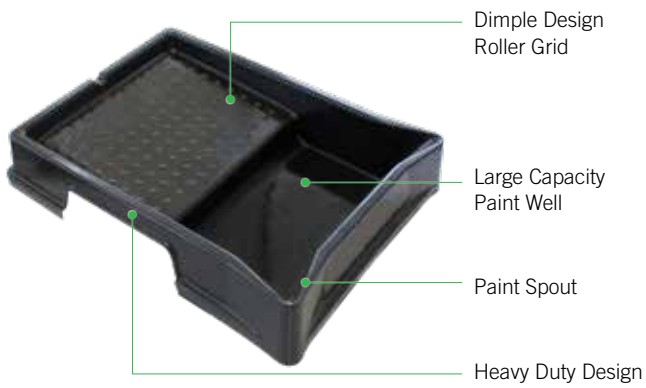

MONARCH TRAY LINER - 3PK



SIZE	CODE	CTN QTY	BARCODE
230mm	MRT-2141	10	9 320090 021411
270mm	MRT-2142	10	9 320090 021428

SIZE	CODE	CTN QTY	BARCODE
3PK 3 x 230mm (Suitable for MRT-2141)	MRTL-2153	6	9 320090 021534
3PK 3 x 270mm (Suitable for MRT-2142)	MRTL-2154	6	9 320090 021541



ROLLER TRAYS

- DISPOSABLE ROLLER TRAY
- DISPOSABLE ROLLER TRAY WITH BRUSH HOLDER



MONARCH DISPOSABLE ROLLER TRAY



MONARCH DISPOSABLE ROLLER TRAY with Brush Holder

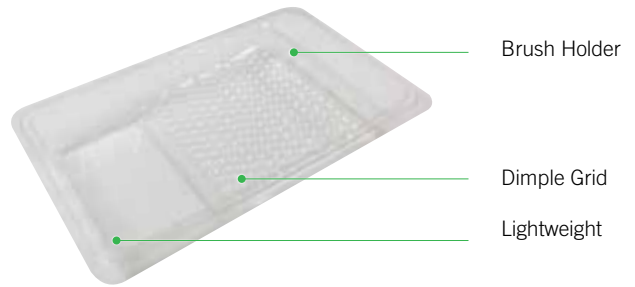

SIZE	CODE	CTN QTY	BARCODE
230mm	RT-1292	50	9 320090 012921

SIZE	CODE	CTN QTY	BARCODE
160mm	RT-1294	100	9 320090 012945



POTS & BUCKETS

- PAINT POT
- METAL PAINT BUCKET



MONARCH DISPOSABLE PAINT POT ■

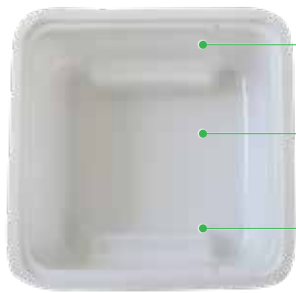



- 600ml Capacity
- Handy Portable Size
- Easy Hand Grips

MONARCH METAL PAINT BUCKET ■



- Litre Measurements
- Metal Handle
- Galvanised Finish
- 4L Capacity

VOLUME	CODE	CTN QTY	BARCODE
600ml	BS-1213	50	 9 320090 012136

VOLUME	CODE	CTN QTY	BARCODE
4L	MPP-1355	24	 9 320090 013553



Tools

Caulking Tools & Guns	61
-----------------------	----

Scrapers	63
----------	----



CAULKING TOOLS

- 3 IN 1 PRO CAULKING TOOL
- HEAVY DUTY CRADLE CAULKING GUN



MONARCH 3 IN 1 PRO CAULKING TOOL ■



CODE	CTN QTY	BARCODE
AT-1036	24	9 320090 010361

MONARCH HEAVY DUTY CRADLE CAULKING GUN ■



CODE	CTN QTY	BARCODE
1380	6	9 320090 113802

MONARCH®

CAULKING GUNS

- CRADLE CAULKING GUN
- SKELETON CAULKING GUN

MONARCH CRADLE CAULKING GUN ■



CODE	CTN QTY	BARCODE
1090	6	9 3200904010903

MONARCH SKELETON CAULKING GUN ■

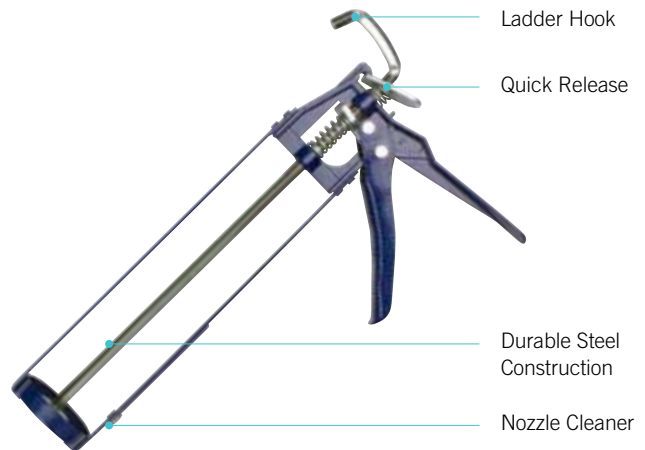

CODE	CTN QTY	BARCODE
1183	6	9 320090011832

MONARCH®

Superior Non-Stick Coating

DURATEK SCRAPERS

Heavy Duty Titanium-Infused Scrapers
Available in 20mm to 150mm
Putty Knife & 5-in-1 Multi-Tool



MONARCH®

SCRAPERS

- HEAVY DUTY SCRAPERS
- HEAVY DUTY PUTTY KNIFE
- HEAVY DUTY 5 IN 1 MULTI TOOL

MONARCH HEAVY DUTY SCRAPERS ■



Hammer End

Comfortable Handle

Full Tang Blade

Flex Blade

SIZE	CODE	CTN QTY	BARCODE
20mm	TM2459	6	9 320090 024597
38mm	TM2460	6	9 320090 024603
50mm	TM2461	6	9 320090 024610
63mm	TM2462	6	9 320090 024627
75mm	TM2463	6	9 320090 024634
100mm	TM2464	6	9 320090 024641
150mm	TM2465	6	9 320090 024658

MONARCH HEAVY DUTY PUTTY KNIFE ■



Hammer End

Comfortable Handle

Full Tang Blade

Putty Knife

SIZE	CODE	CTN QTY	BARCODE
Putty Knife	TM2457	6	9 320090 024573

MONARCH HEAVY DUTY 5 IN 1 MULTI TOOL ■

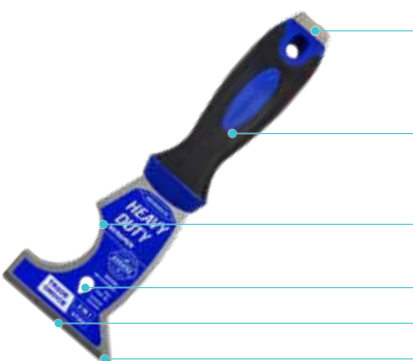

Hammer End

Comfortable Handle

Roller Cover Cleaner

Nail Pull

Chiselled Blade

Can Opener

SIZE	CODE	CTN QTY	BARCODE
5 in 1 Multi Tool	TM2458	6	9 320090 024580



SCRAPERS

PURELINE PLASTIC SCRAPERS



PURELINE PLASTIC SCRAPERS

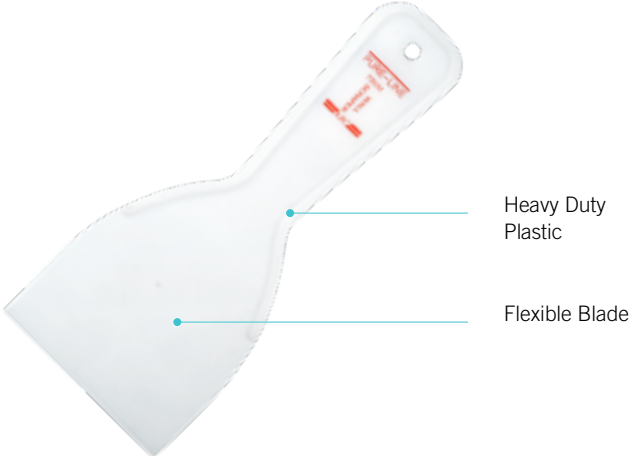

SIZE	CODE	CTN QTY	BARCODE
38mm	AT-1038	12	9 320090 010385
50mm	AT-1050	12	9 320090 010507
75mm	AT-1075	12	9 320090 010750
100mm	AT-1100	12	9 320090 011009
150mm	AT-1151	12	9 320090 011511



Preparation

Accessories	67
-------------	----

Paint Stirrers	68
----------------	----



ACCESSORIES

- BRUSH COMB
- METAL CAN OPENER



MONARCH BRUSH COMB



Metal Comb Tine

Sturdy Plastic Handle

CODE	CTN QTY	BARCODE
AT-1342	12	9 320090 013423

MONARCH METAL CAN OPENER



Durable Metal

Bevelled Edge

CODE	CTN QTY	BARCODE
AT-1005	10	9 320090 010057

MONARCH®

PAINT STIRRERS

- PAINT MIXER
- PLASTIC PAINT STIRRER
- WOODEN PAINT STIRRER

MONARCH PAINT MIXER ■

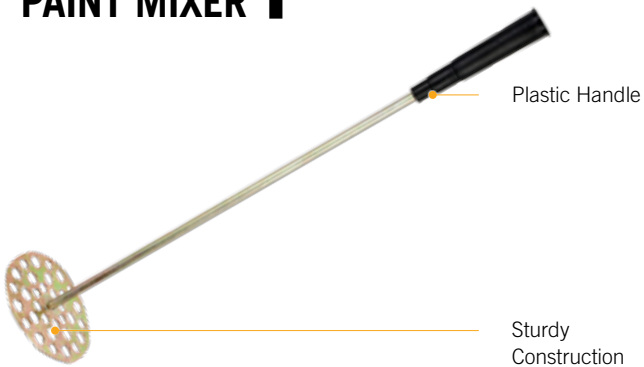

SIZE	CODE	CTN QTY	BARCODE
4L - 10L	PM-1380	6	9 320090 013805
10L - 20L	PM-1370	6	9 320090 013706

MONARCH PLASTIC PAINT STIRRER ■

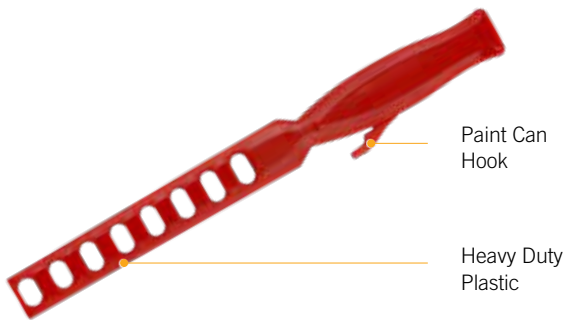

SIZE	CODE	CTN QTY	BARCODE
1L - 4L	PM-1350	6	9 320090 013508

* various colours available

MONARCH WOODEN PAINT STIRRER ■



SIZE	CODE	CTN QTY	BARCODE
1L - 4L	PM-1352	50	9 320090 113529
10L - 15L	PM-1355	50	9 320090 113550



Merchandising

Corflute Signs/Dump Bins

70



MERCHANDISING

- CORFLUTE SIGN
- DUMP BIN

MONARCH CORFLUTE SIGN

MONARCH DUMP BIN



SIZE	CODE	CTN QTY	BARCODE
80cm x 300cm	SP-011	10	 9 320090 000744

SIZE	CODE	CTN QTY	BARCODE
45cm x 45cm x76cm	M-DB-3646	12	 9 320090 036460

www.monarchpainting.com

ONLINE PAINTING RESOURCES & SOCIAL MEDIA

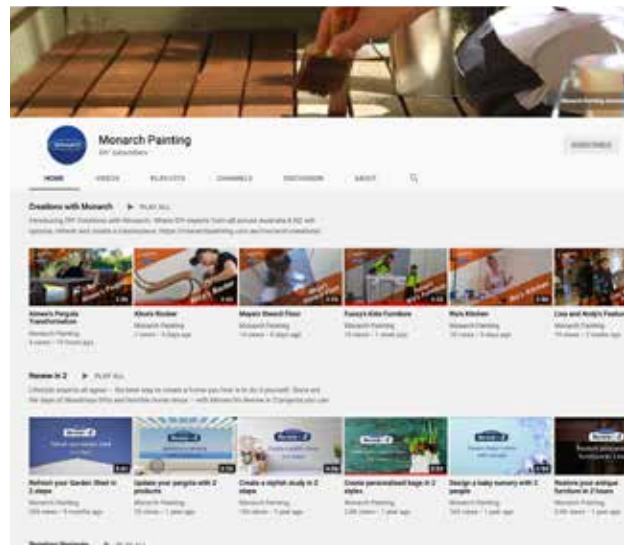
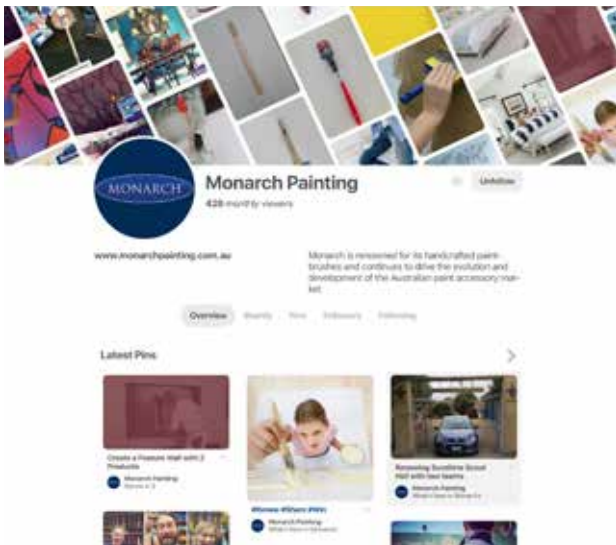
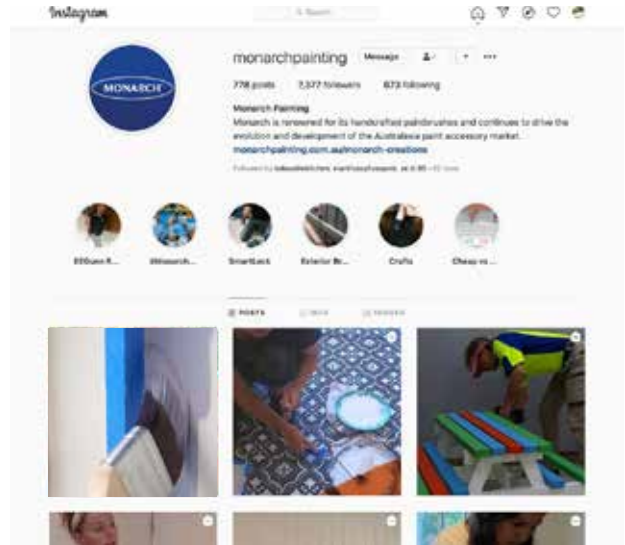
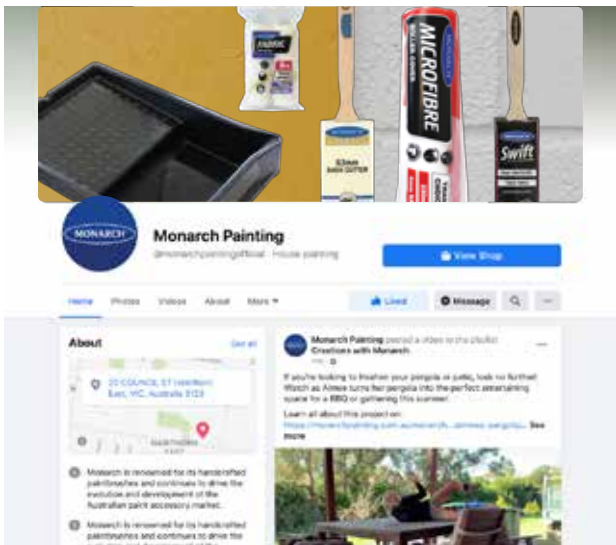

Supplying Quality Painting Tools & Accessories Since 1997



Address: 143-147 National Boulevard, Campbellfield, VIC 3061, Australia
Website: www.monarchpainting.com.au
Email: info@austbrush.com.au
Customer Service: 1800 666 078



Address: P.O. Box 62-037 Sylvia Park, Auckland 1644
Bldg -14 / 9 Manu Street, Otahuhu, Auckland 2024
Website: www.monarchpainting.co.nz
Email: info@austbrush.com.au
Phone: + 64 9 259 4435

